

MADE IN GERMANY

Gear pumps for the chemical industry



WITTE gear pumps for the chemical industry



Contents

CHEM best practice	4
Product overview	6
Standard chemical pump	8
Chemical pump for fine metering	10
Customized solutions	12
Metering systems	14
Size/pumped amount/dimensions	16
Seal range	18
CHEM magnet (magnetic coupling)	20
Quality management	23

The chemical industry is one of the most important economic sectors. It is the foundation and engine for new and innovative products and materials. The manufacture of chemical base substances as raw materials for plastic products, food and chemical products calls for the highest standard of precision and care.

WITTE PUMPS & TECHNOLOGY GmbH has been a reliable technological partner to innovation drivers and giants in the chemical industry for years. We always aim to offer our customers the maximum degree of process reliability with our precision gear pumps and, in doing so, comprehensive quality controls take top priority.

Our CHEM series pumps have been adapted to the requirements and needs of the chemical industry. The various different types of materials and sealing systems make this series flexible and versatile.

Applications in the chemical industry are as wide-ranging as our customers' requirements for our products. Pumps are the heart of the plant and keep the process running. Especially at this point, it is crucial to know and observe the process parameters precisely. The material and design requirements change from medium to medium. The often very challenging and critical media can pose a high risk to humans and the environment.

Maximum care and maximum safety take absolute priority.

CHEM series pumps, like all WITTE pumps, are individually adapted to the requirements and circumstances of the plant and the process in question. All pumps are always updated to meet the latest safety standards.

With countless design versions, our pumps can even be used in different ATEX zones.

We have built up an extensive network of material experts and manufacturers specifically for the CHEM series so we can even offer pumps for use in the most extreme conditions.

The best pump for your process

is not just a slogan to us – it's what drives and inspires us on a daily basis. WITTE PUMPS & TECHNOLOGY GmbH is an international medium-sized machine designer and manufacturer based in Tornesch near Hamburg.

For over 30 years, WITTE has specialised in developing and manufacturing precision gear pumps. Each pump is precisely tailored to the customer's process and needs. WITTE engineers and designers develop custom gear pumps for use in standard or limit ranges.

WITTE has its own subsidiaries in the USA, China, Russia and Malaysia, as well as a number of agents representing it worldwide.



CHEM best practice

CHEM series chemical pumps come as standard with stainless-steel components, or there are special versions with coated or ceramic materials.

The CHEM series was developed for easy maintenance. Separate pump covers make quick inspection of the interior possible from both sides of the pump. To adjust the axial clearance we use spacers that can be varied depending on the process parameters.

There are two temperature control options – electric and hydraulic – to get the pump to the process temperature or keep it there. The hydraulic temperature control option can be fitted with additional heating channels for especially sensitive applications.

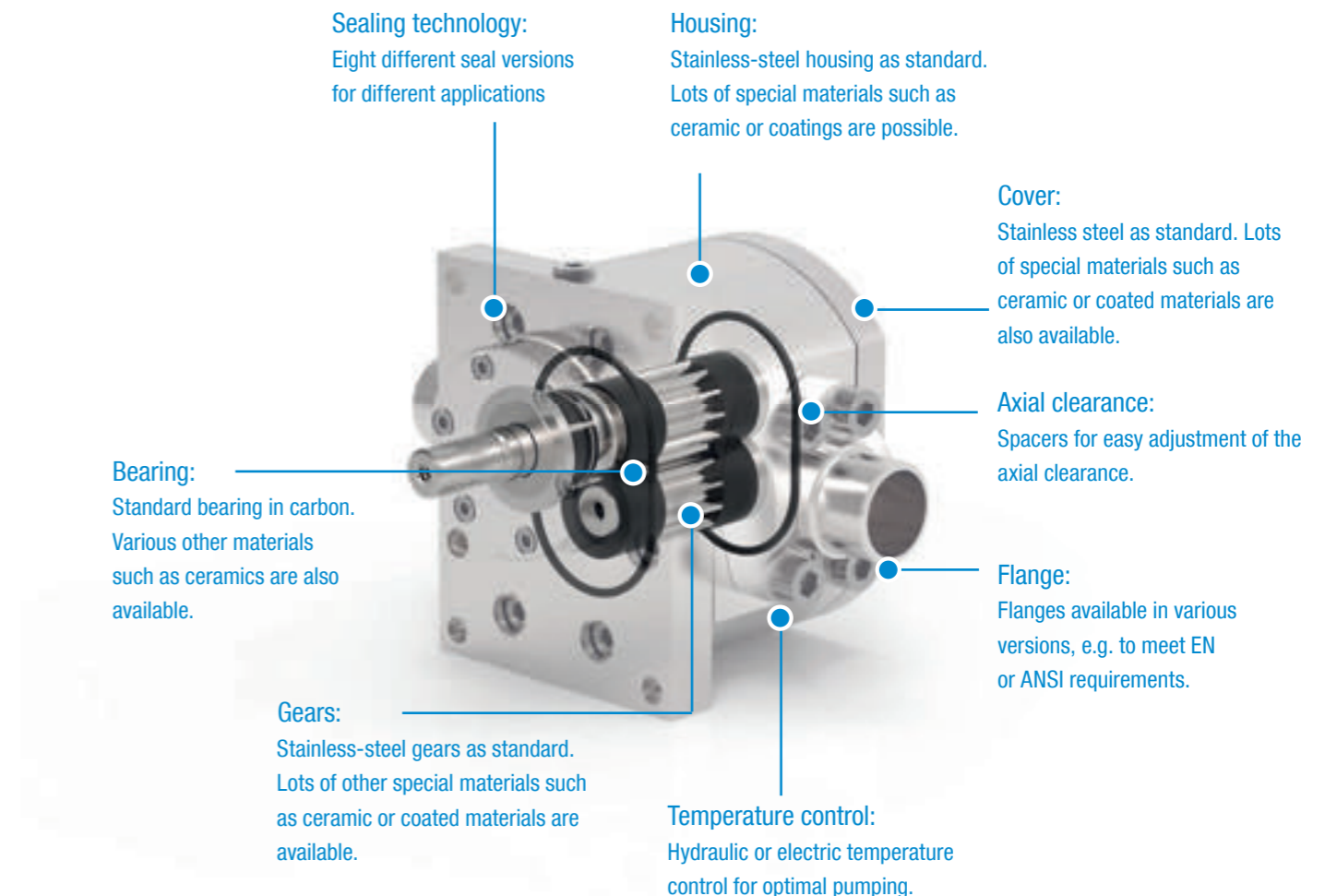

Product overview

CHEM series chemical pumps are predominately used as metering or transfer pumps. Different designs are available based on the requirements and application.

Every day brings something new. The chemical industry is constantly changing. Continuous research and development in this sector creates a constant flow of new products, materials and possibilities. The wide range of applications, processes and materials is ever growing. And new processes are always placing high demands on people and machinery.

The chemical industry supplies the basis and raw materials for semi-finished and end products across a wide range of sectors. All industries – be they agricultural, pharmaceutical, food or plastics – use chemical products.

For over 35 years, we have successfully dedicated ourselves to improving existing processes, implementing new processes and making plants more efficient through state-of-the-art pump technology.

The challenge of new things is what drives us: to create new solutions that only then make new processes possible.

The WITTE chemical range, the CHEM series



Standard chemical pump

Stainless-steel chemical pumps for standard applications and demanding tasks.

Pages 8–9



Chemical pump for fine metering

Mini chemical pumps for precise fine metering.

Pages 10–11



Custom chemical pump

Custom gear pumps. Developed to your specifications and precisely adapted to your application.

Pages 12–13



Metering systems

Metering pumps in different designs. Custom OEM version also available.

Pages 14–15

Standard chemical pump



The CHEM gear pump series was specially developed for the requirements of the chemical industry. This series is used to pump and transfer low-to-medium viscous media and takes care of metering and transfer tasks.

The versatile spectrum of use for these pumps ranges from organic and inorganic chemicals and food-grade lubricants to polymers and pharmaceutical products.

An extensive modular system provides optimal material pairings for corrosive or abrasive media.

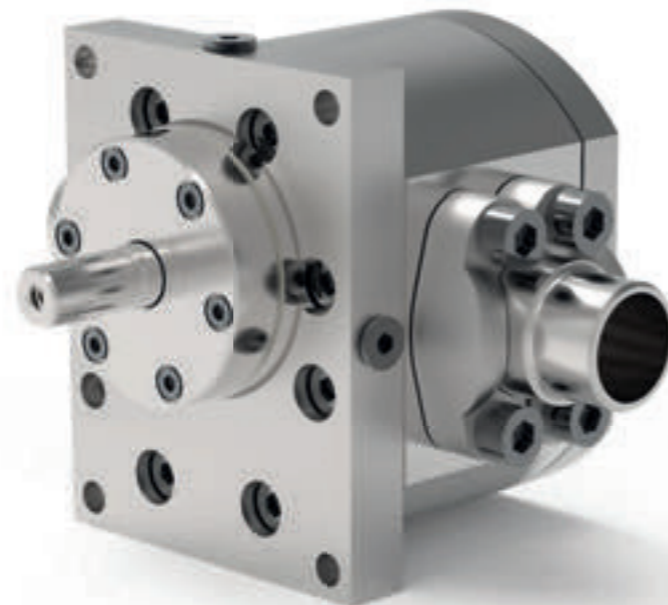

Technical designs

HOUSING
Stainless steel · tantalum · titanium · Hastelloy® · ceramic
GEARS
Stainless steel, Ferralium®, Ferro-Titanit®, Hastelloy®, etc. optionally available with coating · spur gearing
FRICTION BEARINGS
Carbon · NiAg (nickel silver) · silicon carbide · zirconia · tool steel · alum. bronze · optionally available with coating
SHAFT SEALS
Single internal, single external or double mechanical seal · stuffing box · magnetic coupling
HEATING
Steam · water · heat transfer oil · electric

Operating parameters

VISCOSITY
0.5 to 1,000,000 mPa s
TEMPERATURE
Up to 350°C · higher temperatures upon request
SUCTION PRESSURE
From vacuum to max. 15 bar, higher with magnetic drive
DISCHARGE/DIFFERENTIAL PRESSURE
Up to 120 bar
<i>The values listed are maximum values and must not coincide under certain circumstances.</i>
PUMP SIZES
From 0.2 cm ³ /rev. to 24,000 cm ³ /rev.

Application examples

ORGANIC AND INORGANIC CHEMICALS
Alcohols · additives · bases · esters · glycerine · resins · hardeners · isocyanates · monomers · oils · phenols · acids · biodiesel · bitumen · tar · hot melt · adhesives · waxes · etc.
PHARMACEUTICALS AND COSMETICS
Amino acids · lotion · shampoo · vitamins · etc.
POLYMERS
Cellulose · PA · prepolymers · etc.
FOOD
Plant oils · butter · margarine · flavourings · chocolate · fondant · liquorice · chewing gum · vitamins · syrup · gelatine · etc.

Chemical pump for fine metering



The Mini series is based on the CHEM series and extends the range with pumps for extremely fine metering tasks. Amounts from 0.2 cm³/rev. to 2.95 cm³/rev. can be pumped.

This pump type excels at maximum metering precision. The pumps are used for metering additives into extruders, among other applications.



Technical designs

HOUSING
Stainless steel · tantalum · titanium · Hastelloy®
GEARS
1.4112, and also all other processable ceramic and metal materials, such as 1.4571, Ferralium®, Ferro-Titanit®, Hastelloy®, etc. · optionally available with coating
FRICTION BEARINGS
Carbon · NiAg (nickel silver) · silicon carbide · zirconia · tool steel · alum. bronze · special materials · optionally available with coating
SEALS
Stuffing box · magnetic coupling · radial shaft seal ring
HEATING
Steam · water · heat transfer oil · electric

Operating parameters

VISCOSITY
0.5 to 1,000,000 mPa s
TEMPERATURE
Up to 350°C · higher temperatures upon request
SUCTION PRESSURE
Up to max. 15 bar, with magnetic drive max. 25 bar
DIFFERENTIAL PRESSURE
Up to max. 120 bar <i>The values listed are maximum values and must not coincide under certain circumstances.</i>
PUMP SIZES
From 0.2-9-5.5 to 2.95-14-28

Application examples

ORGANIC AND INORGANIC CHEMICALS
Alcohols · additives · bases · esters · glycerine · resins · hardeners · isocyanates · monomers · oils · phenols · acids · biodiesel · bitumen · tar · hot melt · adhesives · waxes · etc.
PHARMACEUTICALS AND COSMETICS
Amino acids · lotion · shampoo · vitamins · etc.
POLYMERS
PS · PET · PC · PA · PMMA
FOOD
Plant oils · margarine · flavourings · chocolate · fondant · liquorice · chewing gum · vitamins · syrup · gelatine · etc.

Custom/OEM solutions



WITTE offers modified chemical pumps for OEM customers. These pumps are usually specially tailored to the customer's requirements. WITTE works with the customer to analyse the pumping task and draw up an initial solution. A pump is designed and prototype created depending on the required amount. The customer has ample op-

portunity to test this prototype, and then the results are discussed and optimised together. The pumps can also be fitted with the customer's name plate if desired and delivered quickly by order contract.



Technical designs*

HOUSING
1.4301
GEARS
1.4301
FRICTION BEARINGS
SiC
SEALS
Radial shaft seal ring
HEATING
Unheated

Operating parameters*

VISCOSITY
20 to 500 mPa s
TEMPERATURE
300°C
SUCTION PRESSURE
1 to 15 bar a
DIFFERENTIAL PRESSURE
16 bar
PUMP SIZES
10.2-25-32 (pumped amount: 0.15 to 36 l/min)

* Custom design for metering fire extinguishing foam additives into a water jet

Application examples

FIRE EXTINGUISHING FOAM/DISTILLATION/EXTRUSION
A pump for metering foam into a water jet in order to produce fire extinguishing foam on fire engines.

Metering systems/technology

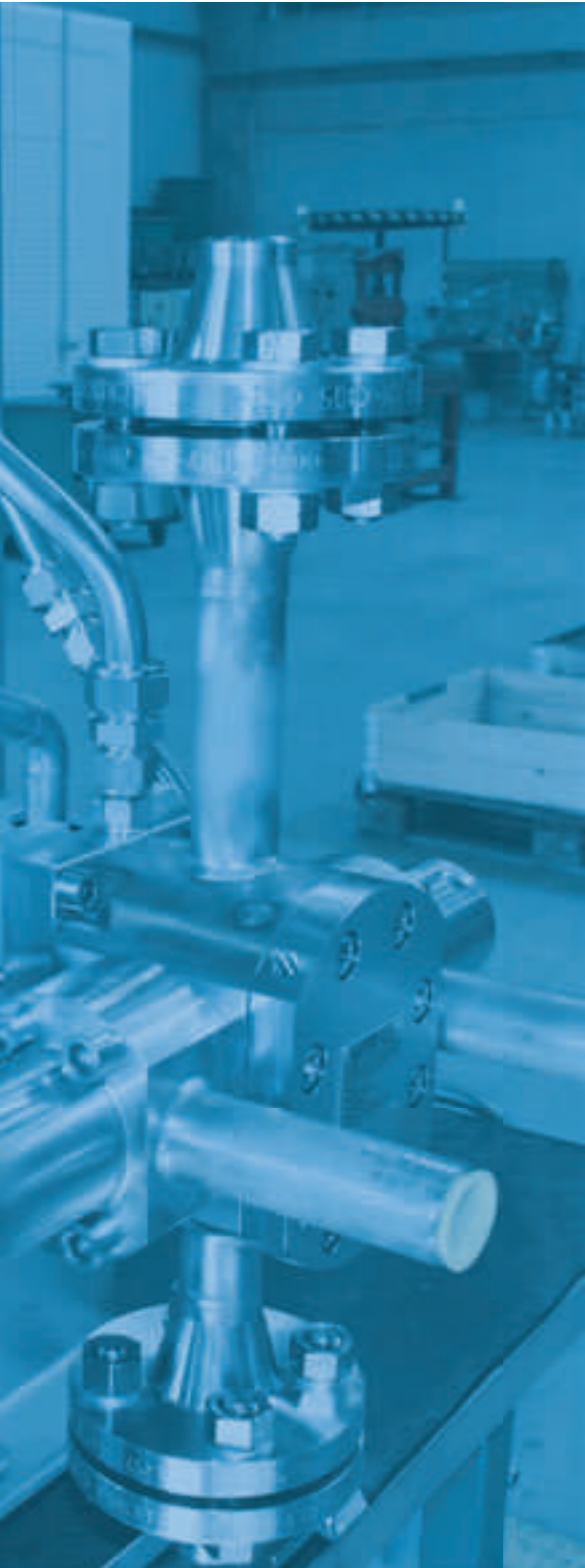

Gear pumps are highly suitable for precise volumetric metering with high reproducibility. When used in combination with a mass flow meter and a control system, a self-regulating, absolutely precise pumping unit is created. A wide range of interfaces can be used to program the mass flow meter.

Once defined, the mass flow meter instantly forwards even the smallest changes in flow to the connected drive unit and regulates the volumetric flow so that it always stays within the tolerance range.



Sample structure of a metering system

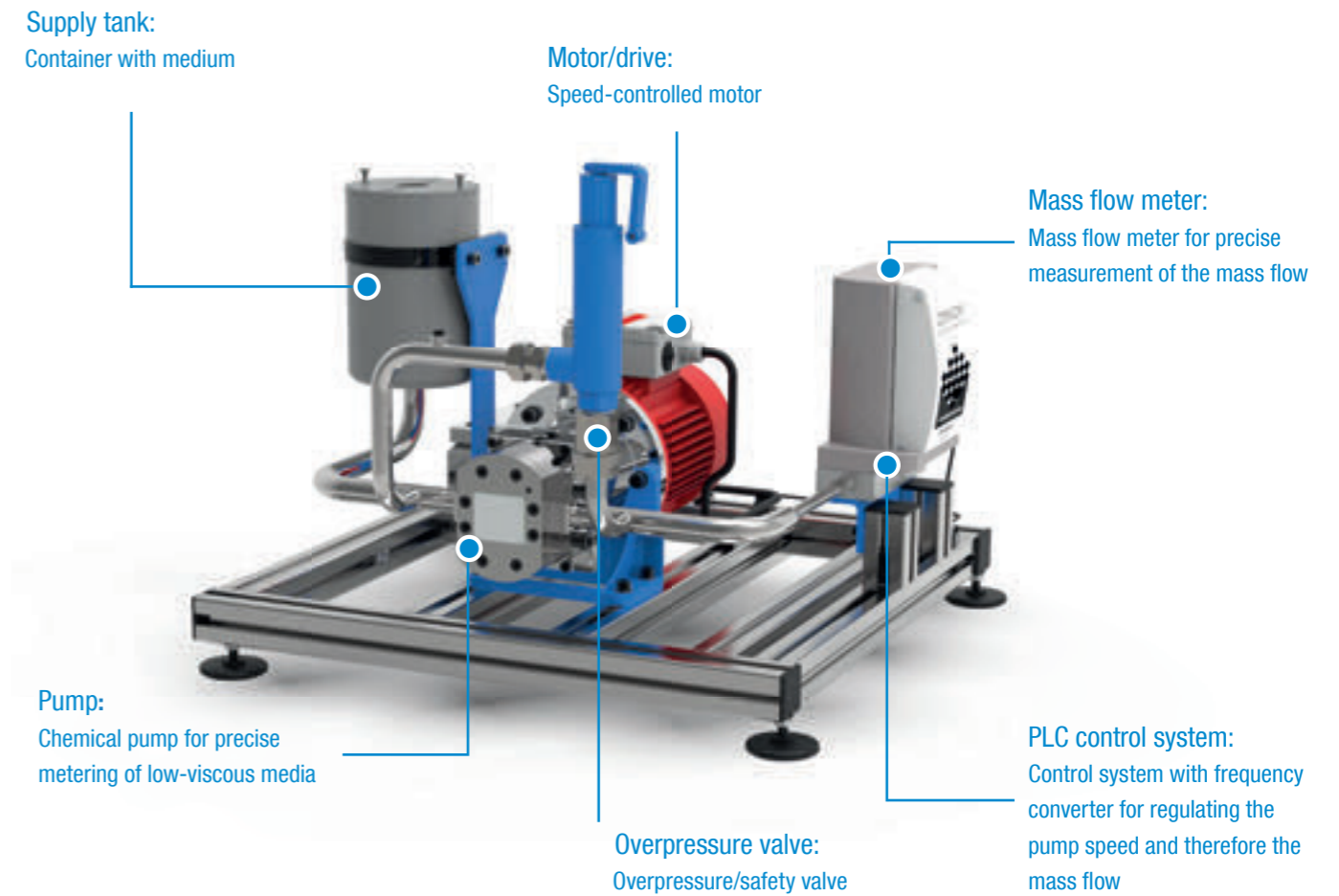

Size/pumped amount/dimensions

for standard CHEM gear pumps

Pump sizes

PUMP SIZE	SPECIFIC VOLUME (CM ³ /U)	FLOW RATE (L/H)*1	PUMPENGRÖSSE	SPECIFIC VOLUMEN (CM ³ /U)	FLOW RATE (L/H)*1
CHEM 1,28-22-6	1,28	20–200	CHEM 176-70-70	176	990–9900
CHEM 2,78-22-13	2,78	40–400	CHEM 371-90-90	371	1.600–16.200
CHEM 4,7-22-22	4,7	70–700	CHEM 716-110-110	716	2.500–25.300
CHEM 10,2-28-28	10,2	140–1.400	CHEM 1.342-140-140	1.342	3.800–37.800
CHEM 25,6-36-36	25,6	280–2.800	CHEM 3.200-180-180	3.200	6.900–69.100
CHEM 46,3-45-45	46,3	410–4.100	CHEM 6.100-224-224*2	6.100	11.000–106.000
CHEM 92,6-56-56	92,6	650–6.500	CHEM 12.000-280-280*2	12.000	17.000–170.000

*1 The pumped amount depends on the product being pumped and the operating conditions.
*2 Only available as custom solution

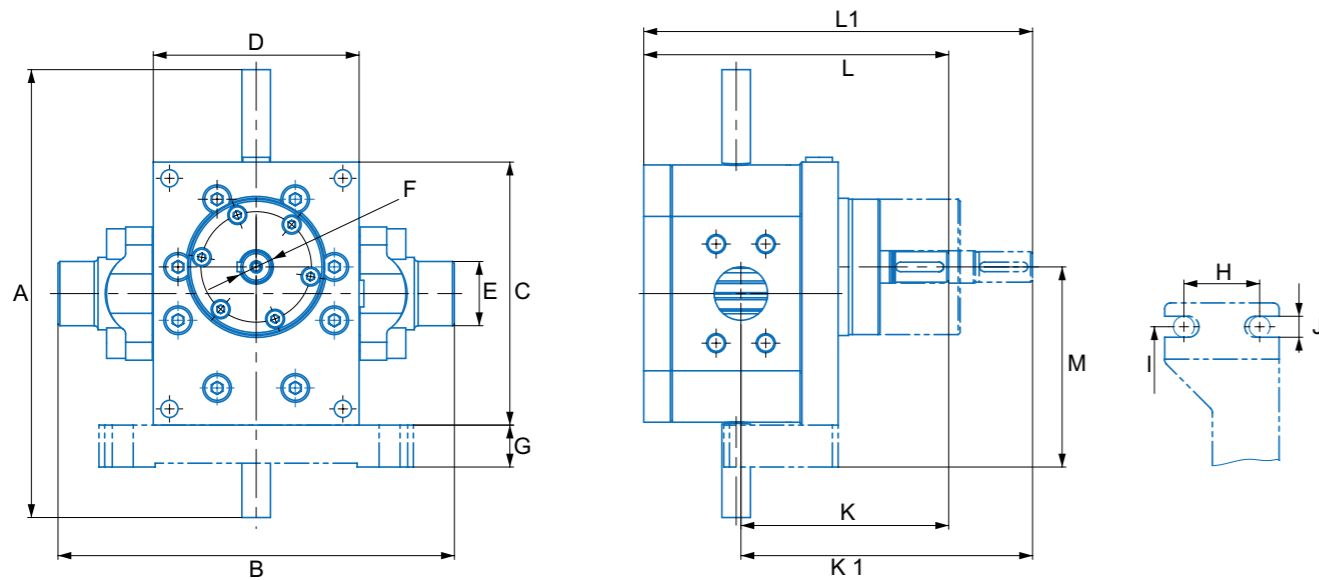

CHEM dimensions

PUMP SIZE	A	B	C	D	E∅	F∅	G	H	I	J	K	K1	L	L1	M	WEIGHT
CHEM 1,28-22-6	200	116	112	80	20/15	11	18	40	110	9	83	110	120	147	85	6 kg
CHEM 2,78-22-13	200	116	112	80	20/15	11	18	40	110	9	86,5	113,5	127	154	85	6 kg
CHEM 4,7-22-22	200	180	112	80	21,3	11	18	40	110	9	91	118	136	163	85	6 kg
CHEM 10,2-28-28	235	208	138	108	33,7	16	22	40	130	11	109	138	160	189	105	15 kg
CHEM 25,6-36-36	250	214	152	114	48,3	19	16	60	140	12	124	157	188	221	110	20 kg
CHEM 46,3-45-45	234	244	176	134	60,3	24	25	75	170	14	148	186	226	265	13,5	26 kg
CHEM 92,6-56-56	360	264	210	168	60,3	32	27	100	220	20	195,5	239,5	289,5	333,5	160	50 kg
CHEM 176-70-70	350	346	258	208	76,1	38	27	115	250	22	225,5	275,5	338,5	388,5	191	125 kg
CHEM 371-90-90	498	416	300	269	88,9	48	42	130	310	28	265	329	405	469	237	220 kg
CHEM 716-110-110	470	488	380	310	114,3	60	42	180	410	28	319	478	384	543	287	340 kg
CHEM 1.342-140-140	600	538	454	340	168,3	70	47	230	430	28	410	457	612	669	344	500 kg
CHEM 3.200-180-180	800	*1	590	440	219,1	*2	65	285	520	33	617	617	902	902	450	700 kg

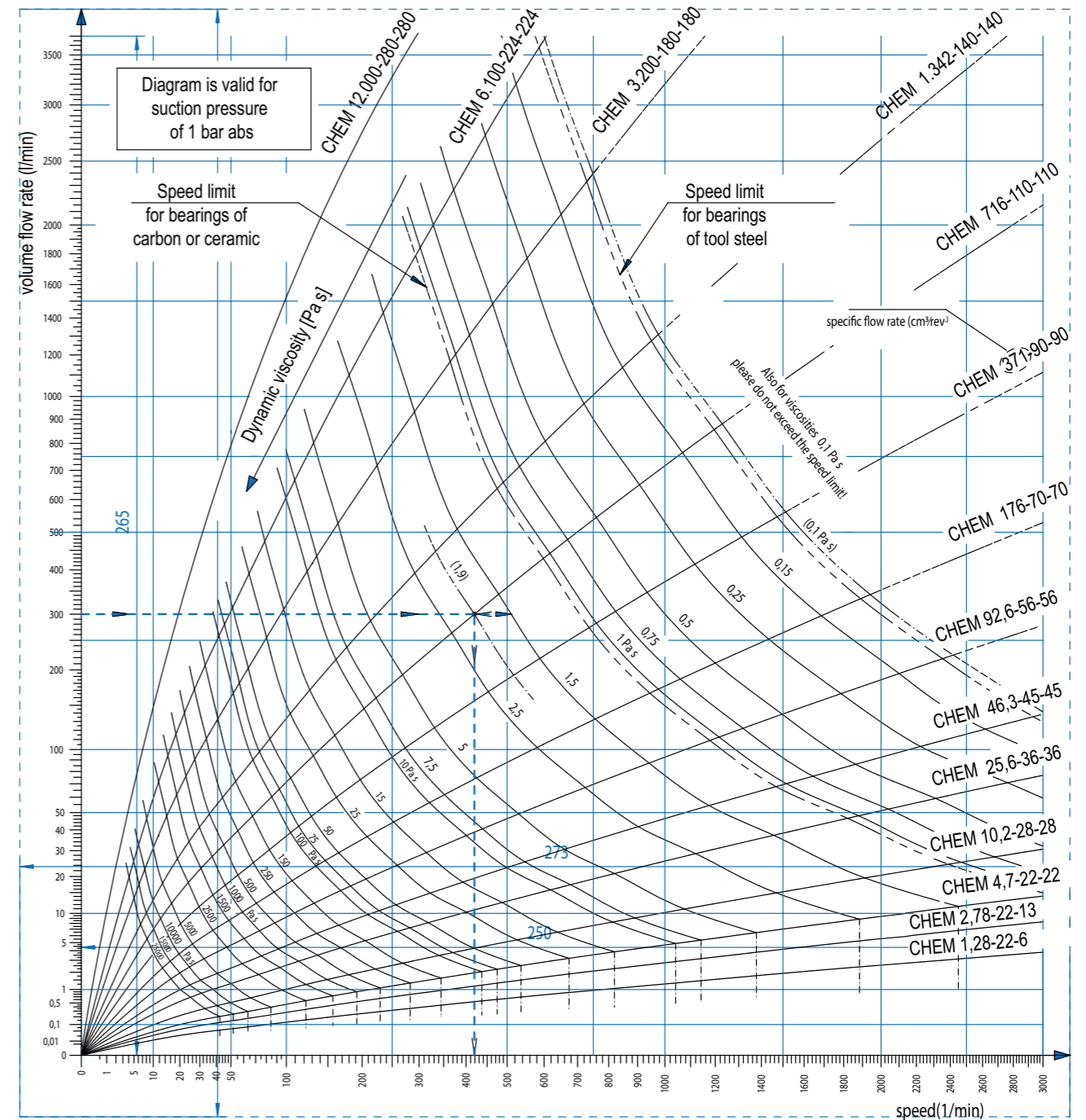

Seals



Each rotating pump has a drive shaft that must be sealed somehow. A wide range of systems and seals can be used for this purpose.

Different systems are used depending on the pump type and application area. The selection of seal types is determined by the process parameters. Pressure, temperature and viscosity are crucial factors that affect or limit the seal selection.



Single mechanical seal (ED)

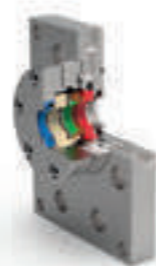

Vacuum mechanical seal (AD), buffered without pressure

PRESSURE SUCTION SIDE	0,8 to max. 15 bar(a)	Vacuum to max. 2 bar(a)
VISCOSITY (mPas)	0,5–50.000 mPas	0,5–100.000 mPas
TEMPERATURE (°C)	Max. 300 °C	Max. 250 °C

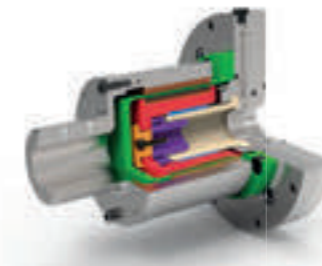

Synchronous magnetic coupling



Radial shaft seal ring

PRESSURE SUCTION SIDE	Max. 700 bar(a)	1 max 3 bar(a)
VISCOSITY (mPas)	1 to 30.000 mPas	1 to 10.000 mPas (cP)
TEMPERATURE (°C)	450 °C	Max. 250 °C



Single stuffing box



Double stuffing box

PRESSURE SUCTION SIDE	1 to max. 10 bar(a)	Vacuum to max. 15 bar(a)
VISCOSITY (mPas)	1–10.000.000 mPas	1–10.000.000 mPas
TEMPERATURE (°C)	Max. 300 °C	Max. 300 °C

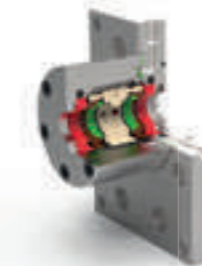

Double mechanical seal, buffered (DD)



Quenched internal mechanical seal (EDQ)

PRESSURE SUCTION SIDE	Vacuum to max. 15 bar(a)	1 to max. 15 bar(a)
VISCOSITY (mPas)	0,5–1.000.000 mPas	0,5–50.000 mPas
TEMPERATURE (°C)	Max. 300 °C	Max. 250 °C

CHEM magnet (magnetic coupling)

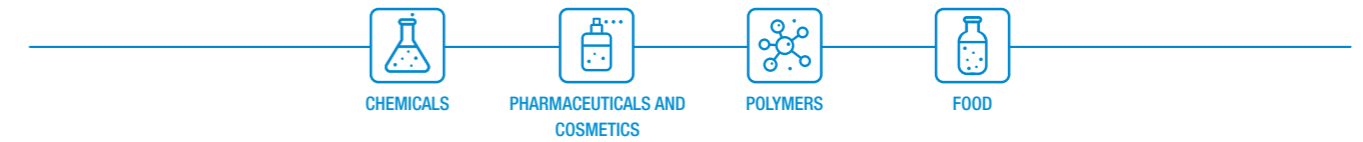

Special situations call for special solutions. Our magnetic coupling is safe, reliable and flexible to use.

We offer a wide range of versions of this seal type. The seal is a combination of a hermetic seal at the pump and a touchless drive. In contrast to conventional magnetic couplings, our version has a separate rotor bearing that transfers only the torque to the drive shaft. There is therefore no additional load on the pump bearings by the weight of the internal rotor.

The result:
No wear, maximum life expectancy and increased operational safety.

A modular system ensures that individual components of the seal that come into contact with the medium can be easily replaced and tailored to the properties of the medium.

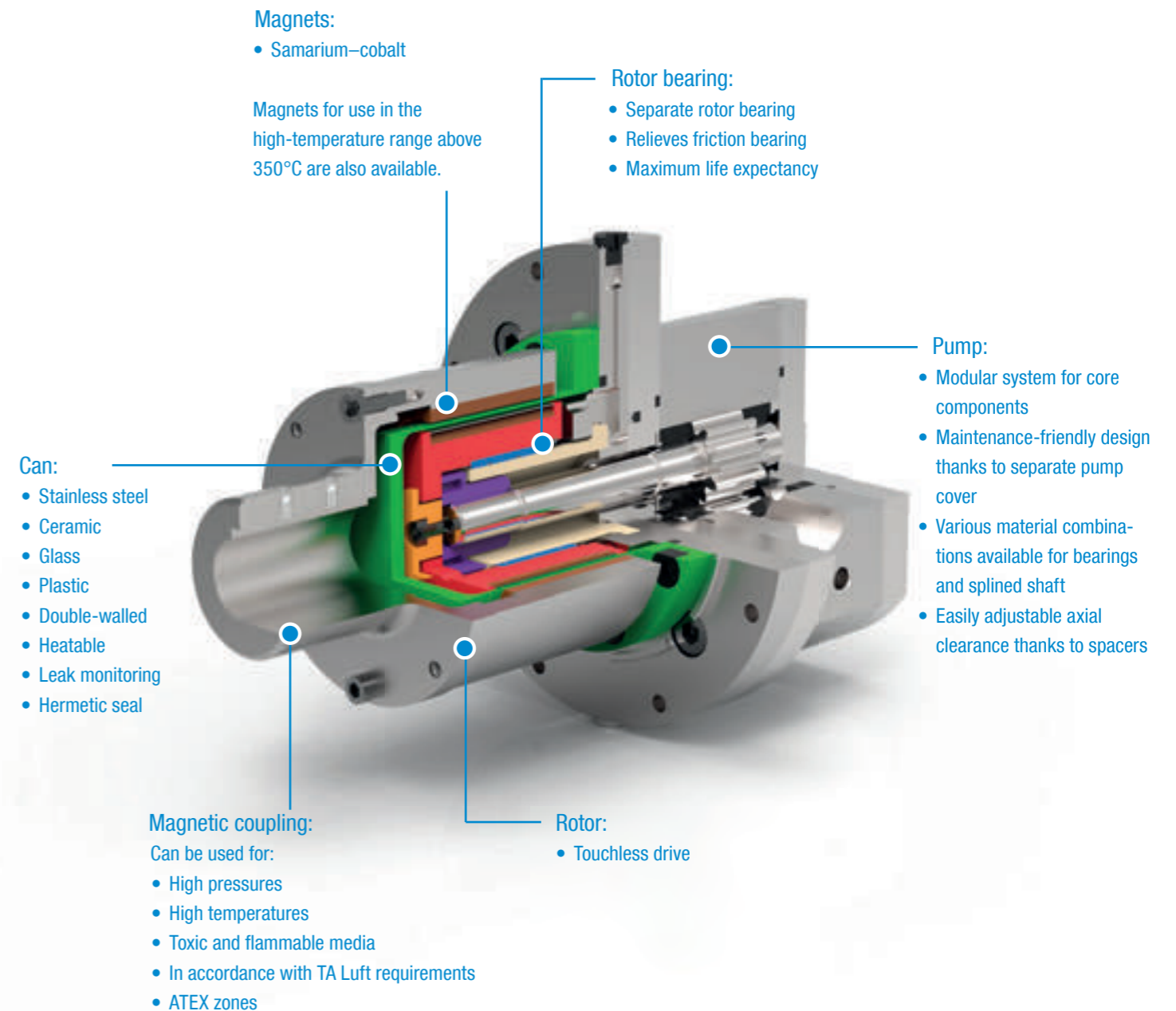

What drives us

The challenge of constantly discovering and developing new things drives us. We have been supporting our industry customers and plant engineers with our expert knowledge for over 35 years. Our employees bring their passion and commitment every day to develop the optimal pump solution.

Whether your process is standard or has special requirements, we develop and manufacture gear pumps for a number of applications. We always keep all of the requirements in mind and work with customers and partners to develop the best solution together for every single pump. Often what starts as a custom solution becomes a new standard product.

The chemical industry is constantly changing. New methods, processes and basic materials always pose new challenges. Our expertise and experience ensure that plants can be implemented with WITTE gear pumps and processes run optimally.

Quality management

Quality plays a crucial role at WITTE and runs through every area of the company. It is reflected not only on our company's products but also in its processes and in the work itself. That's why WITTE PUMPS & TECHNOLOGY GmbH is certified under the current DIN ISO 9001 standard. Regular internal and external audits ensure continuous improvement. The principles of modern business operations are assured by a code of conduct.

Certificates:

- DIN EN ISO 9001
- AEO
- EAC
- TA Luft

Working with and pumping chemicals and critical media calls for maximum care. All of the core components of our pumps are therefore tested in modern 3D and optical measurement processes for dimensional stability, clearance classes and quality criteria. Compliance with our quality standards is the most important consideration when it comes to our gear pumps.

Methods and processes are under constant audit and improvement, which is also reflected in our

DIN ISO 9001 certification. We inspect not only ourselves but also all of our partners and suppliers to ensure that quality standards are met.

In addition to technical solutions for process requirements, WITTE also sees maximum safety for humans and the environment as a top priority.

CHEM pumps can be used in EX zones and can also be designed in accordance with TA Luft directives upon request.

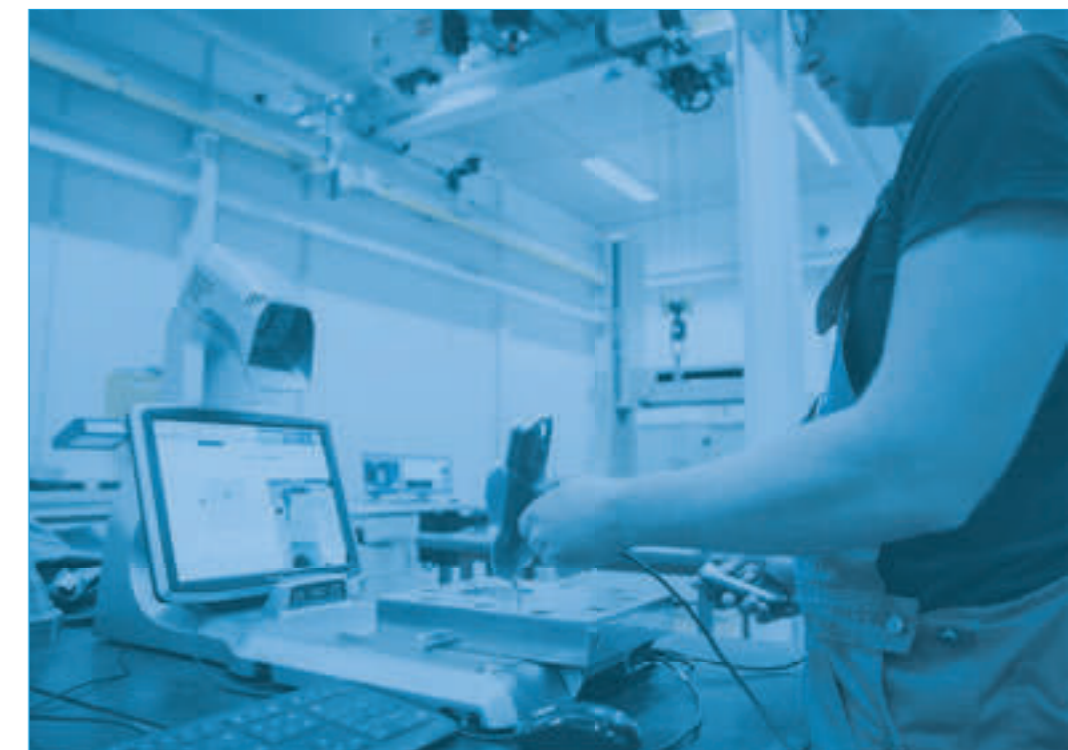

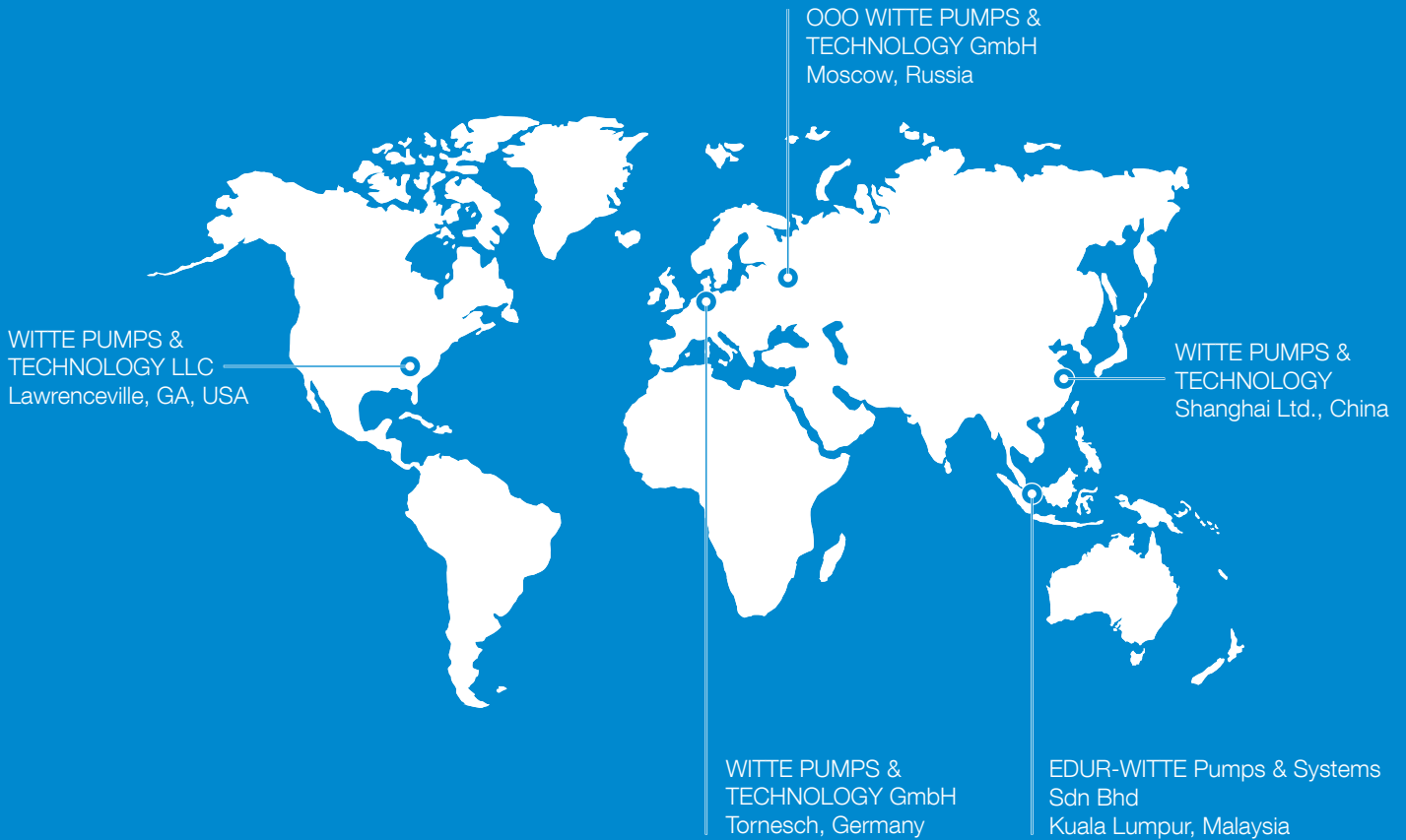

WITTE WORLDWIDE



All of our sales partners can be found at www.witte-pumps.com

WITTE PUMPS & TECHNOLOGY GmbH
 Lise-Meitner-Allee 20
25436 Tornesch/Hamburg, Germany

 +49 (0)4120 706 590
 +49 (0)4120 7065 949

 info@witte-pumps.de
 www.witte-pumps.com

